

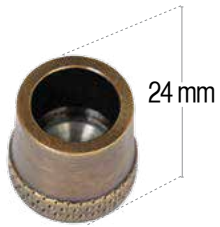

Ayaklar
Brackets

G70



24 mm

70.2016 Ø16



24 mm

70.2020 Ø20



24 mm

70.2025 Ø25

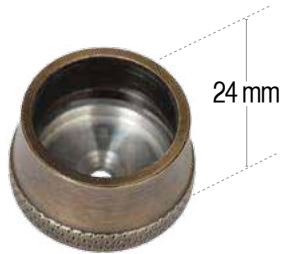

24 mm

70.2030 Ø30



24 mm

70.2035 Ø35



24 mm

70.2040 Ø40

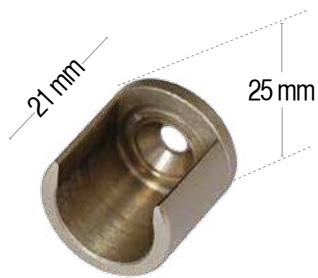

21 mm

25 mm

70.1116

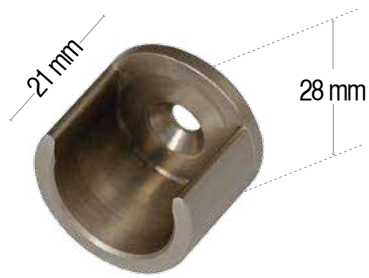

21 mm

28 mm

70.1120

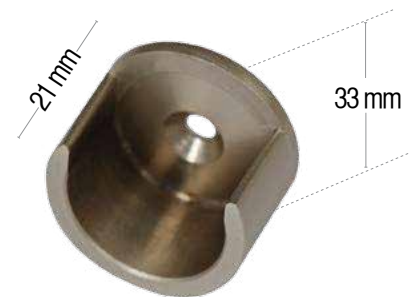

21 mm

33 mm

70.1125



21 mm

38 mm

70.1130



21 mm

43 mm

70.1135



21 mm

48 mm

70.1140



70.2751 Ø25-30

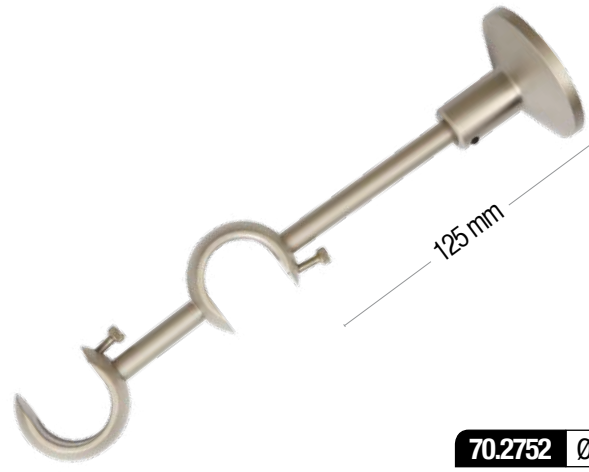

70.2752 Ø25-30



70.2753 Ø20-25-30



70.2754 Ø20-25-30



70.2215 Ø20-25-30-35-40



70.2219 Ø20-25-30-35-40



70.2217 Ø20-25-30-35-40



70.2610



70.2550 Ø20-25-30-35-40



70.2560 Ø20-25-30-35-40



70.2732



70.2303

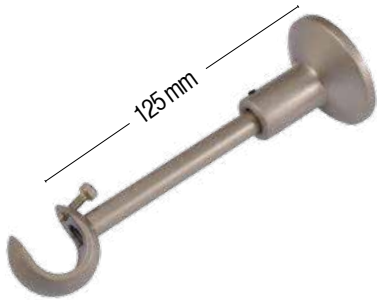

70.2751 Ø20

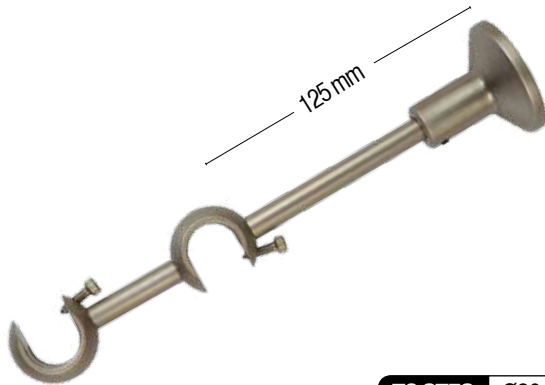

70.2752 Ø20

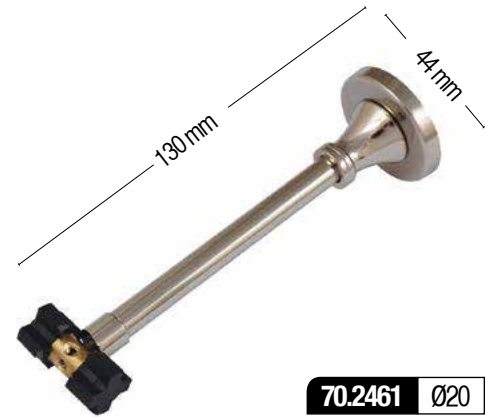

70.2461 Ø20

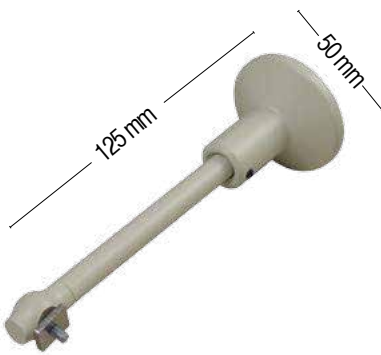

70.5111 Ø20

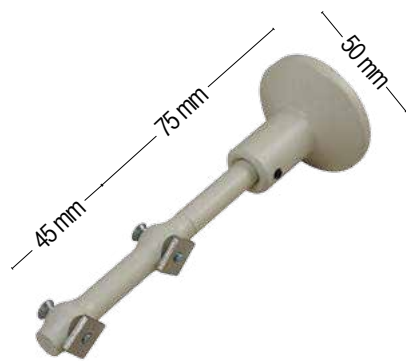

70.5112 Ø20



70.2471 Ø25-30



70.5021 Ø30

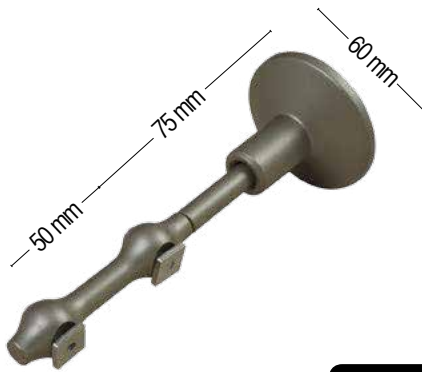

70.5022 Ø30



70.5011 Ø25-30



70.5012 Ø25-30

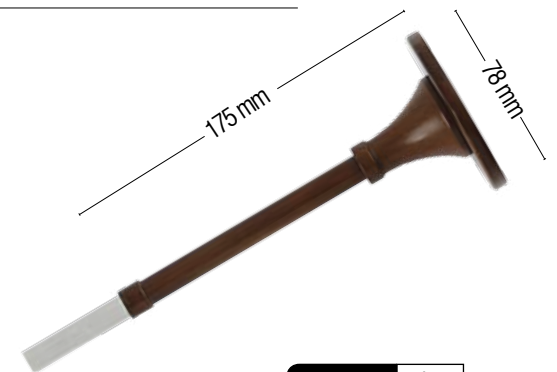

70.2481 Ø55

Ayaklar | G70

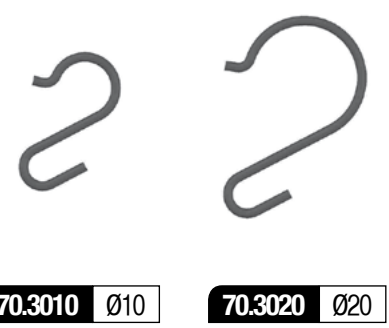
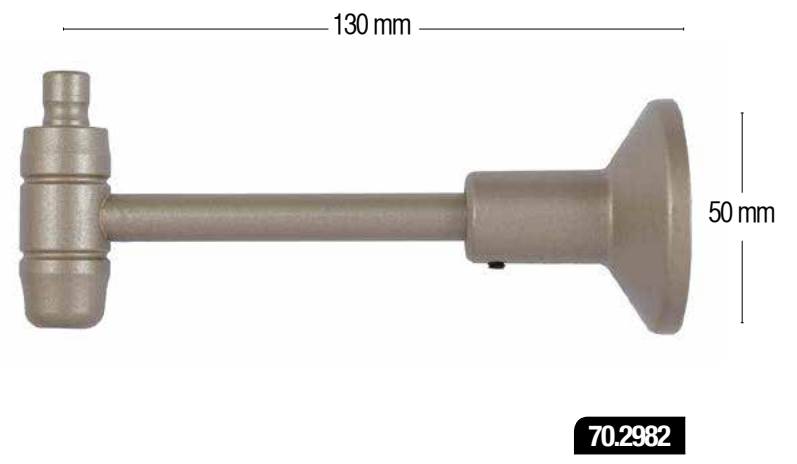
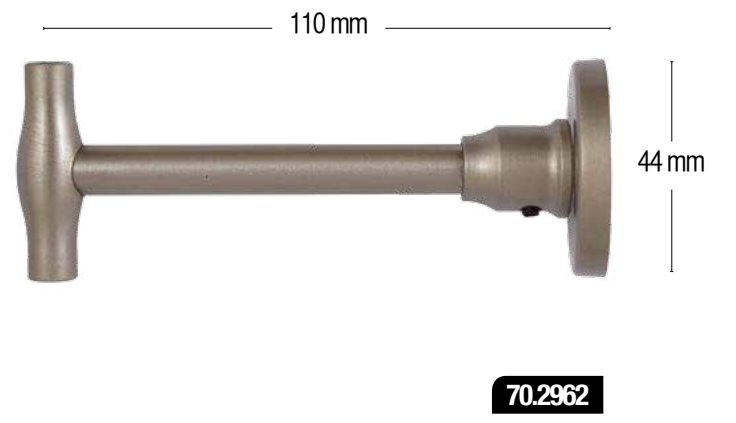
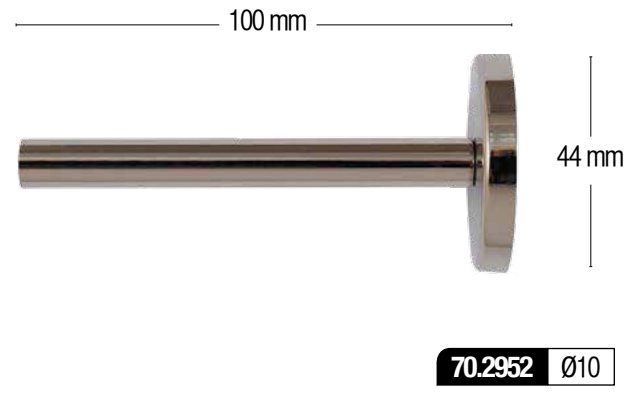
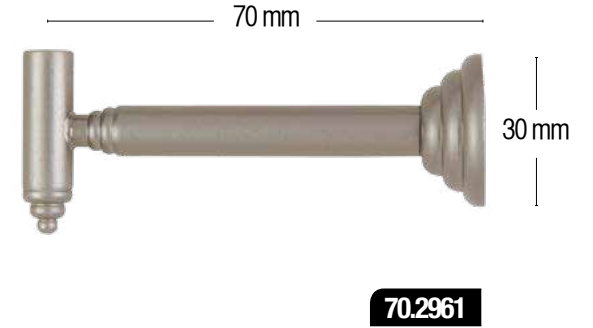
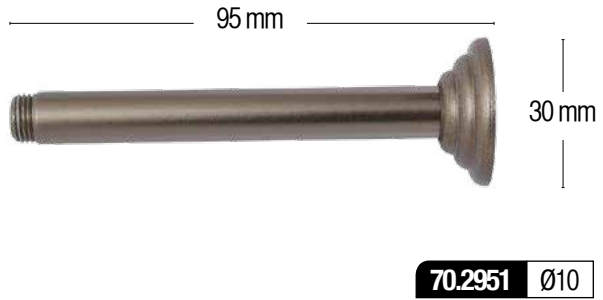

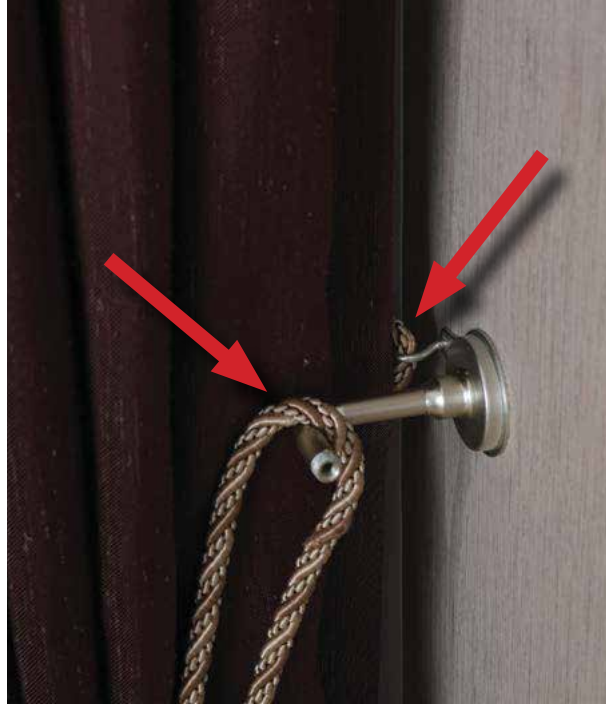

70.2972



70.2992

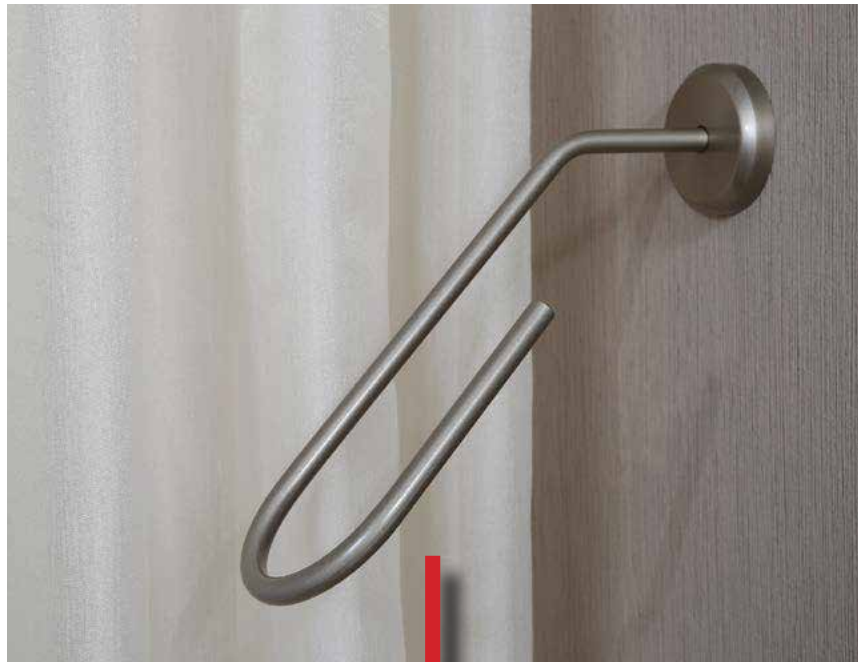
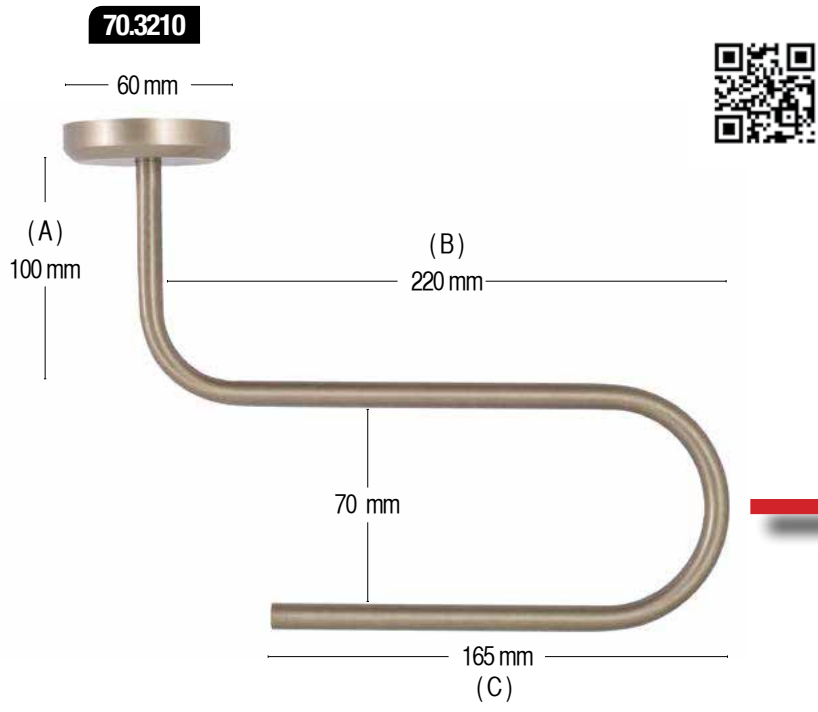

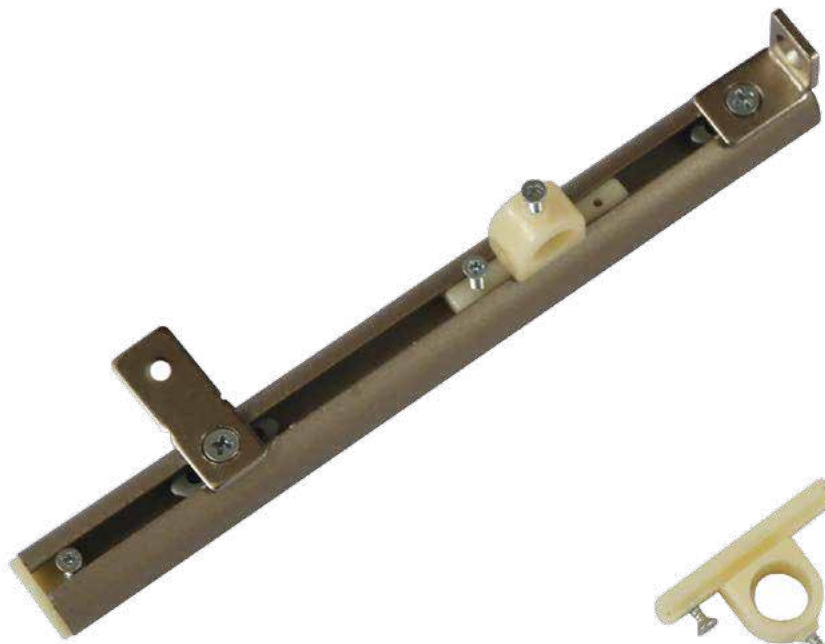

70.6012



70.6013



70.6015

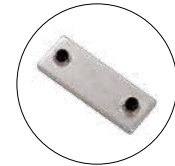

70.4017



70.4012



70.4014



70.4012



70.4013



70.4015



70.4016 Ø18 - Ø23 - Ø28 - Ø33 - Ø38



70.4018

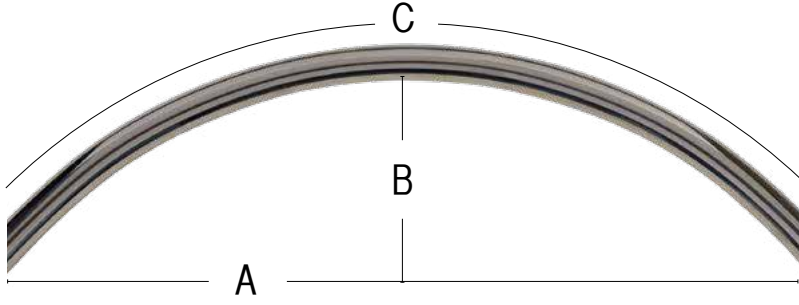

Üretim için A-B-C ölçülerinden en az ikisi bilinmelidir.

90.1010

Boru kavisli dönüş.



90.1030

Ray profil kavisli dönüş.

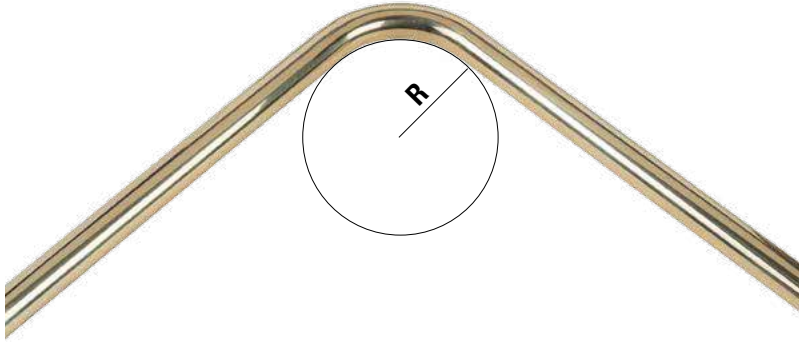

90.1020

* Boru köşe dönüş.

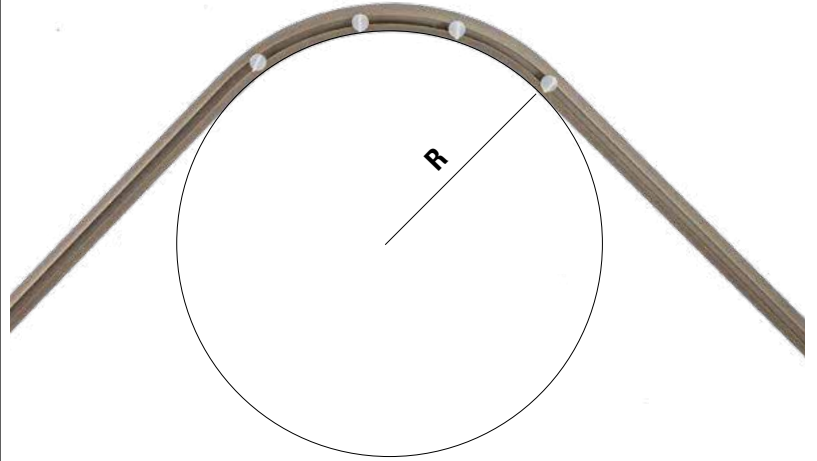

90.1040

* Ray profil köşe dönüş.

Ürün Kodu	Ürün Adı	Profil Ebat - mm	Dönüş Radüsü -R- (Yarıçapı)
98.3520	Rustik rayı yuvarlak	Ø20 mm	103 mm
98.4010	Rustik rayı kare	14x18 mm	135 mm
98.4030	Hastane rayı	13,5x30 mm	98 mm
98.1010	Boru	Ø16x1 mm	33 mm
98.2010	Boru	Ø20x1 mm	43 mm
98.6010	Boru	Ø25x1 mm	63 mm
	Boru	Ø30x1 mm	66 mm



98.2210



98.2220



98.2230



98.2240





98.4121

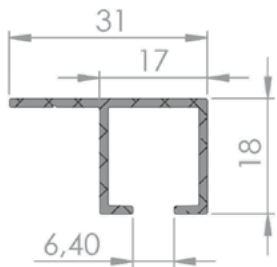

98.4023

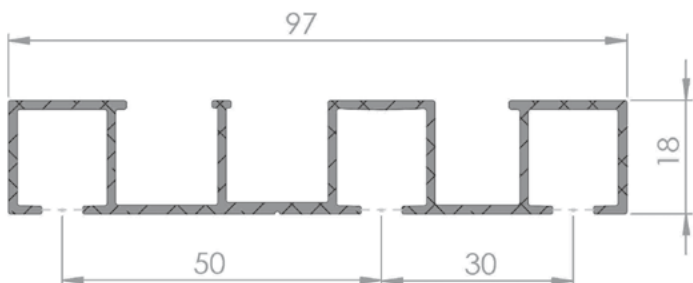

98.1000

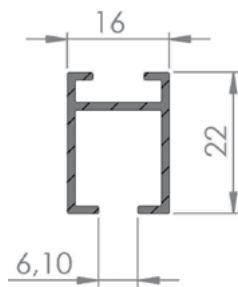
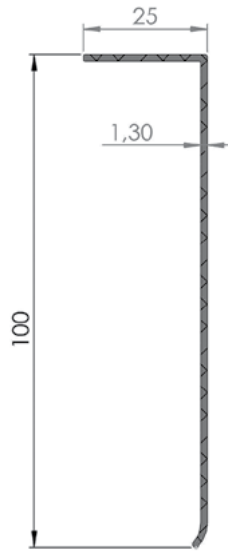

812



818



45.1010



45.1011



70.3010

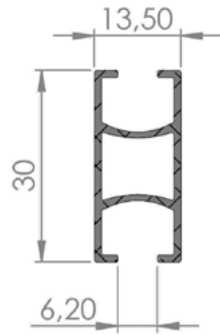



















98.4030



45.1000



70.5211 Ø12

Ürün Kodu Product Code	Renk Color	Çap Dia	Profil Profile	Malzeme Material
98.1010	101,103,105	10, 16, 20, 25, 30		Pirinç Brass
98.1011	101,103,105	8,10		Pirinç Brass
98.2010	107	10, 16, 20, 25, 30		Paslanmaz Çelik Stainless Stell
98.2011	107,108	8, 10		Paslanmaz Çelik Stainless Stell
98.6010	818	20, 25, 30		Demir Iron
98.4010	601, 603, 605, 607 811,812, 813, 814, 815, 816, 817, 818, 819	14x18		Alüminyum Aluminium
98.3520	601, 603, 605, 607 811,812, 813, 814, 815, 816, 817, 818, 819	20		Alüminyum Aluminium
98.3600	107, 110	22x50		Alüminyum Aluminium
98.3111	811,812, 813, 814, 815, 816, 817, 818, 819	30		Alüminyum Aluminium
98.3112	811,812, 813, 814, 815, 816, 817, 818, 819	30		Alüminyum Aluminium
98.3110	811,812, 813, 814, 815, 816, 817, 818, 819	25, 30	 	Alüminyum Aluminium
98.3012	701, 702, 703, 707, 715, 716, 718, 719, 720, 721, 724, 725, 726, 727, 737	30, 40	 	Alüminyum Aluminium
98.3014	701, 702, 703, 707, 715, 716, 718, 719, 720, 721, 724, 725, 726, 727, 737	30, 40	 	Alüminyum Aluminium
98.3010	401, 402, 403, 404	30, 55	 	Alüminyum Aluminium